

Model/Modelo/Modèle 35730LF

▲ Specify Finish
Especifique el Acabado
Précisez le Fini

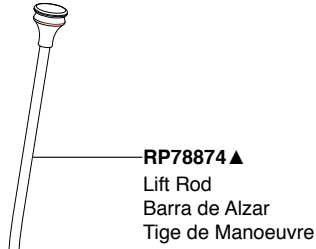

RP78874 ▲
Lift Rod
Barra de Alzar
Tige de Manoeuvre

RP78875 ▲
Handle Assembly
Conjunto de manija
Montage de la manette

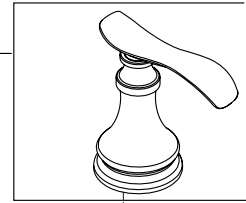

RP78871
Stem Unit Assembly, Seat & Spring,
Bonnet Nut & Washer
Ensamble de la Unidad del Vástago,
Asiento y Resorte, Bonete y Arandela
Obtuteur, siège et ressort, écrou à
chapeau et rondelle

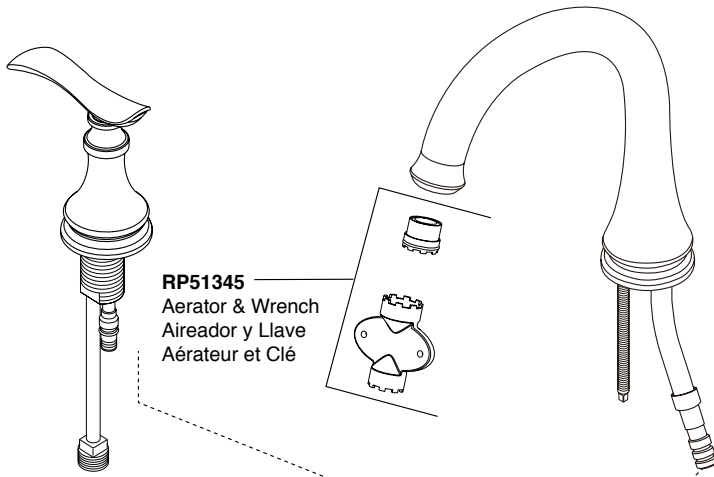
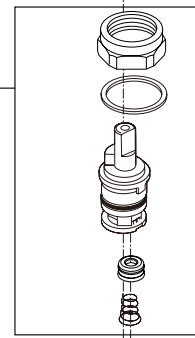

RP51345
Aerator & Wrench
Aireador y Llave
Aérateur et Clé

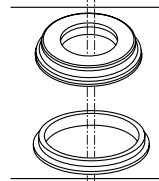

RP78884 ▲
Flange & Gasket
Brida y Empaque
Bride et Joint

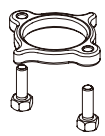

RP78886
Hose Assembly &
O-Rings
Ensamble de la
manguera y Aros-O
Tuyau souple, et
joints toriques



RP47029
Bucket
Soporte
Support

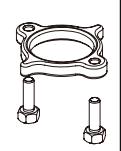
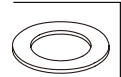

RP47423
Washers (2), Nuts (2) &
Screws (4)
Arandelas (2), Tuercas
(2) y Tornillos (4)
Rondelles (2), Écrous(2)
et Vis (4)

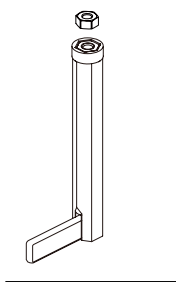

RP47030
Nut & Wrench
Tuerca y Llave
Écrou et clé

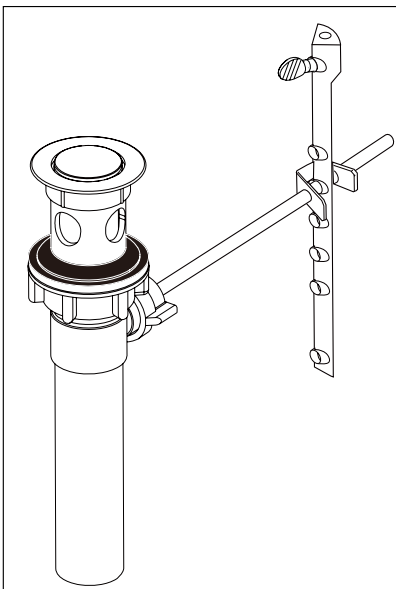

RP62472 ▲
Plastic Pop-Up Less Lift Rod
Desagüe Automático de Plástico
Menos la Barra de Alzar
Renvoi Mécanique en Plastique
Sans la Tige de Manoeuvre